





Fitting for top-running glass doors up to 250 kg (551 lbs.), with surface mounted running track or running track flush with the ceiling. Ceiling mounting.

Product highlights

-  **Comfort** High quality steel ball bearing rollers for quiet, smooth running, even with heavy weights
- Reliability** Very safe thanks to positive-fit glass fixing

Technical specifications

-  Max. 250 kg (551 lbs.)
-  Max. 4000 mm (13'1 15/32")
-  Max. 3000 mm (9'10 1/8")
-  8–16 mm (5/16" to 5/8")

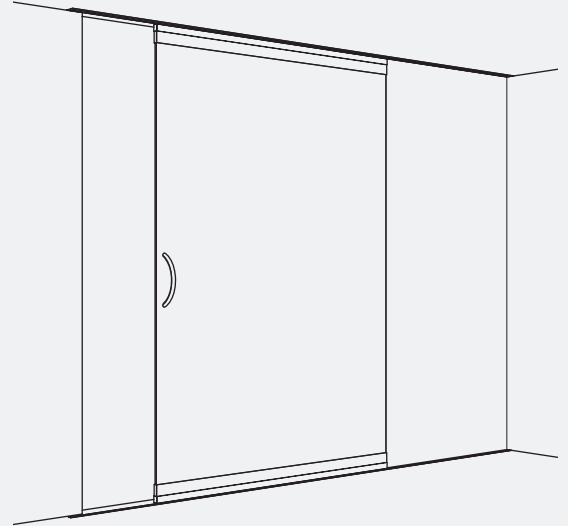

Installation examples

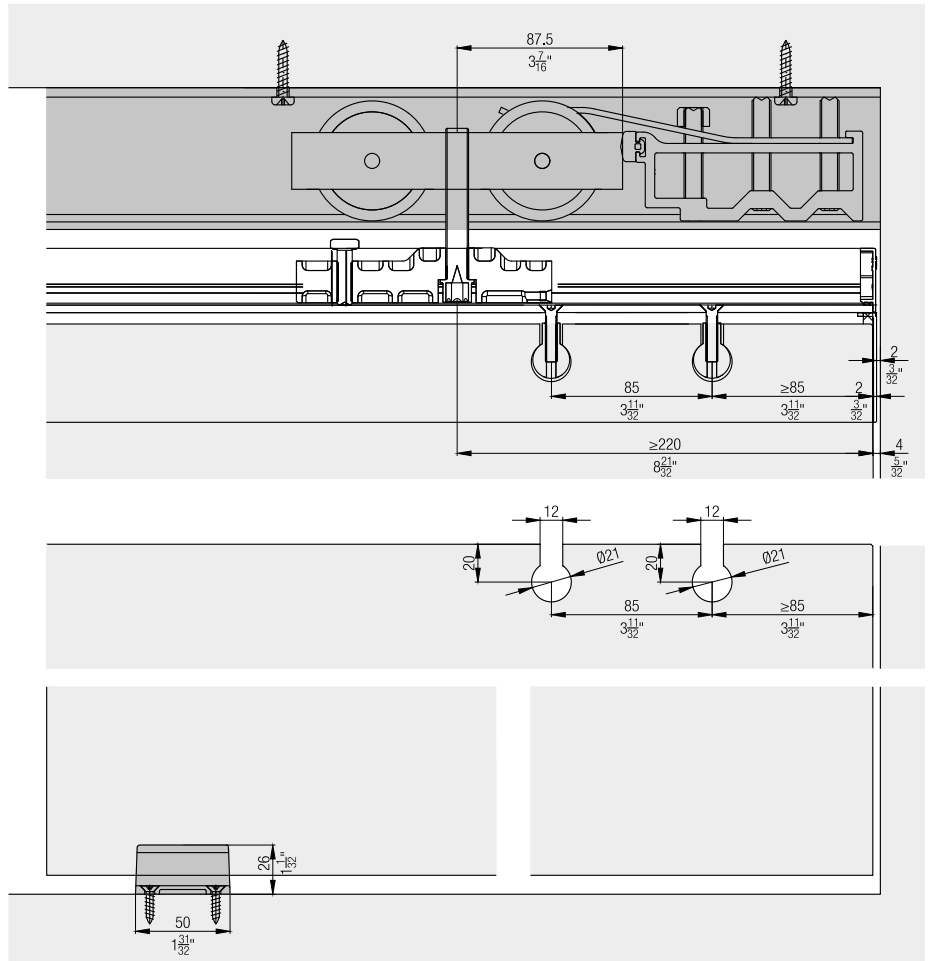
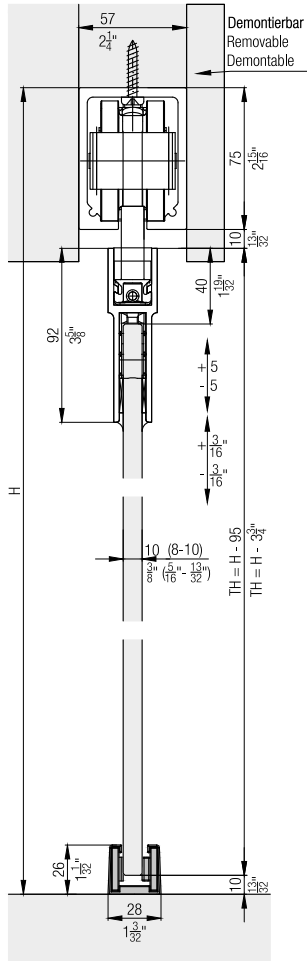



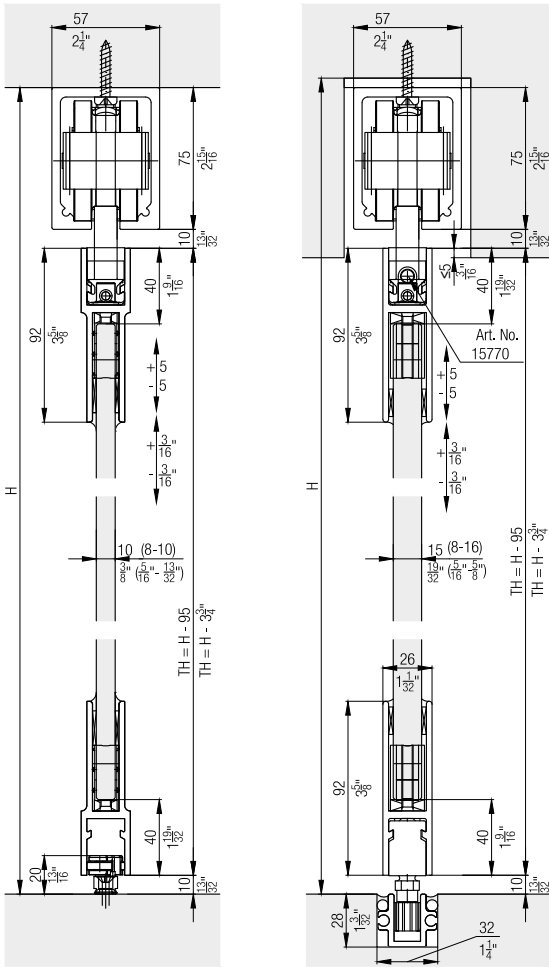

Further installation examples



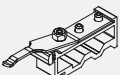

Set for 1 glass door up to 250 kg (551 lbs.)

	No.
Hawa Junior 250 G, for 1 door	21738



Set consisting of:

		21738	No.
	Two-wheeled running gear, M12, plastic wheels	2	20731
	Track stopper, with adjustable retention spring	2	20995
	Suspension plate, with suspension bolt M12	2	21739
	Rubber buffer, 29x11 mm (1 5/32"x7/16"), for screw fixing	1	13114
	Cover cap for glass vsuspension profile, plastic, anthracite	2	20907
	Adjustment and fixing key for suspension assembly	1	10793

Suspension and glass retaining profiles

		mm (inch)	No.
	Glass suspension/retainer profile, aluminum, anodized, brushed, glass up to 8–16 mm (5/16"–5/8")	6,500 (21' 3 29/32")	21783
		cut to size	21784
	Glass suspension/retainer profile, aluminum, glass up to 16 mm (5/8")	6,500 (21' 3 29/32")	13158
	Glass suspension/retainer profile, aluminum, glass up to 16 mm (5/18")	cut to size	13159
	Glass suspension/retainer profile, aluminum, anodized, brushed, glass up to 8–10 mm (5/16"–13/32")	6,500 (21' 3 29/32")	21781
		cut to size	21782
	Glass suspension/retainer profile, aluminum, glass up to 10 mm (13/32")	6,500 (21' 3 29/32")	10348
		cut to size	10349
	Multi purpose suspension and retainer profile, aluminum, anodized, undrilled	6,500 (21' 3 29/32")	10345
		cut to size	12915

Cover caps





		No.
	Cover cap for glass suspension/retainer profile 21783/21784/13158/13159, glass up to 16 mm (5/8"), plastic, anthracite	21085
	Cover cap for glass suspension/retainer profile 21781/21782/10348/10349, glass up to 10 mm (13/32"), plastic, anthracite	21512

Glass holder

Order 4 pieces per suspension and glass retaining profile

		No.
	Glass holder insert, plastic, with countersunk head screw, M6x30 mm (1/4"x1 3/16")	10792

Bottom guides

		No.
	Guide, rattle proof, with suspension block, plastic, 14 mm (9/16")	13781
	Bottom guide, rattle proof, with self-adhesive sliders for satinised glass, glass thickness 8–12.7 mm (5/16"–1/2"), chrome-plated, matt	16029
	Bottom guide, rattle proof, with self-adhesive sliders for satinised glass, glass thickness 8–12.7 mm (5/16"–1/2"), stainless steel look	21267
	Rattle-proof mounted guide, with wheels	24905
	Connecting bolt for bottom guide track, 6x40 mm (1/4"x1 9/16"), steel, zinc-plated	13759

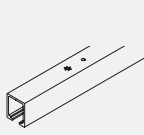

Running tracks

		mm (inch)	No.
	Running track, aluminum, anodized, pre-drilled	4,000 (13' 1 15/32")	20988
		6,000 (19' 8 7/32")	20612
		cut to size	20990

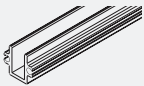

Guide tracks

		mm (inch)	No.
	Guide track, aluminum, anodized, pre-drilled	6,000 (19' 8 7/32")	13688
		cut to size	13690







Wall connection

		mm (inch)	No.
	Wall profile, aluminum, anodized	2,500 (8' 2 7/16")	17020
		3,500 (11' 5 25/32")	17021
	Wall profile, aluminum, stainless steel look, brushed	2,500 (8' 2 7/16")	20119
		3,500 (11' 5 25/32")	20120
	Seal profile, black, for wall profile	2,500 (8' 2 7/16")	16452
		3,500 (11' 5 25/32")	16453







Protective edge trims

		mm (inch)	No.
	Protective edge trim, for 10 mm glass (13/32"), plastic, transparent	3,000 (9' 10 1/8 ")	13822
		6,000 (19' 8 7/32")	13600
	Protective edge trim, for 12 mm glass (15/32"), plastic, transparent	3,000 (9' 10 1/8 ")	13908
		6,000 (19' 8 7/32")	13907
	Protective edge trim, for 12.7 mm glass (1/2"), plastic, transparent	3,000 (9' 10 1/8 ")	13912
		6,000 (19' 8 7/32")	13911
	Double-sided adhesive tape for protective edge trim	50,000 (164' 1/2 ")	22820
	Rubber profile self-adhesive, black, for 8–12,7 mm (5/16"–1/2") glass thickness, glass distance 4 mm	5,000 (16' 4 27/32")	19442
		10,000 (32' 9 11/16")	19443
		50,000 (164' 1/2 ")	19444
	Rubber profile self-adhesive, translucent, for 8–12,7 mm (5/16"–1/2") glass thickness, glass distance 4 mm	5,000 (16' 4 27/32")	19445
		10,000 (32' 9 11/16")	19446
		50,000 (164' 1/2 ")	19447

Integrated locks

		No.
	Bar bolt lock for 17 mm profile cylinder (21/32"), with retention pin	16760
	Bar bolt lock for 22 mm round cylinder (7/8"), with retention pin	16761
	Bar bolt lock for square/hexagon socket, with retention pin	16762
	Bar bolt lock for 17 mm (21/32") profile cylinder, with guide pin and fixing parts	18484
	Bar bolt lock for 22 mm (7/8") round cylinder, with guide pin and fixing parts	18485
	Bar bolt lock for square/hexagon socket with guide pin and fixing parts	18486
	Security rose 16 mm (5/8"), for profile cylinder 17/61 mm (21/32"/2 13/32"), chrome nickel steel	18502
	Spacer for security rose for 17 mm (21/32") profile cylinder, 10 mm (13/32") glass	18493
	Spacer for security rose for 22 mm (7/8") round cylinder, 10 mm (13/32") glass	18494
	Floor-mounted sleeve with oblong hole and chromium-plated brass spring cover	13787
	Rosette for floor-mounted sleeve	17326
	Strike plate, steel, chrome-plated	13130

Accessories

		No.
	Bottom door stopper, with centering, stainless steel look	21473
	Bottom door stopper, with centering, chrome-plated, matt	20773
	Hawa assembly wegde, for 1 door	15770
	Connecting pins to profiles, 2-piece set	21347
	Centering assembly grey, for all glass sliding doors	18619
	Centering assembly black, for all glass sliding doors, to wall profile	18663

Wall connection

Optimal wall connection for all-glass sliding doors with unprotected glass edge.

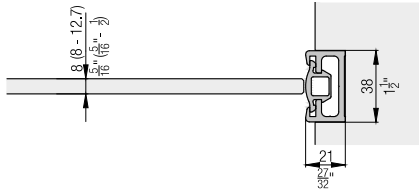

Glass edge protection

The transparent glass edge protection profile and the self-adhesive rubber profile are recommended for protecting the vertical glass edges. The latter not only protects the glass edges, it also reduces drafts to a minimum.

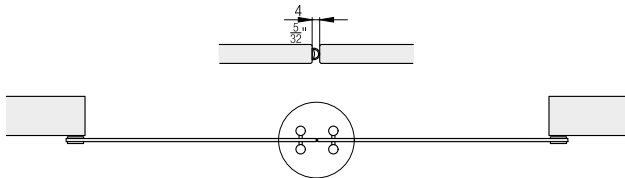

Individual solution

The suspension profile (12915) allows for the use of commercial as well as customer-specific suspension and glass retaining profiles.

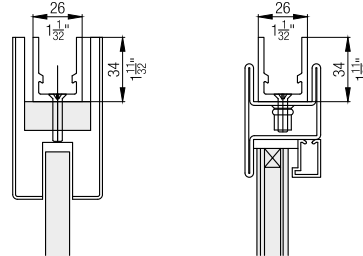

Integrated locks

An integrated bar bolt lock, suitable for the 17 mm (21/32") profile cylinder, 22 mm (7/8") round cylinder and a square/hexagonal socket, is available to secure the all-glass sliding doors.

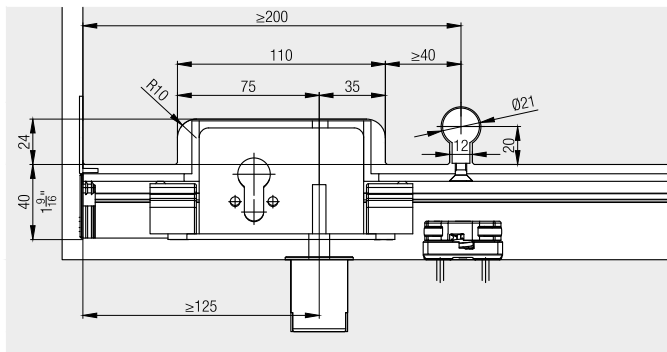

Accessories

- General accessories from page 487
- Glass recommendations from page 504

Planning/execution

Further information about the product can be found on www.hawa.com.